

LogiLink®

Wall Mount for Amazon Echo Alexa

Art. No.: BP0031
BP0032



Protect and stabilize Amazon Echo.

Features:

- » Frees up desk and counter space while protecting the Amazon Echo
- » Maintains the overall look of the Amazon Echo
- » Heavy-Duty steel construction protects the speaker better than plastic mounts
- » High quality powder-coated finish prevents scratches and rust
- » Easy installation

Specification:

Rated Load	1.5kg/3.3lbs
Material	Steel T=2.0
Product Dimension	154 x 120 x 100mm
Product Weight	Around 247g

Part-No.	Color	EAN Code
BP0031	Black	4052792045949
BP0032	White	4052792045956



a. Stud Mount

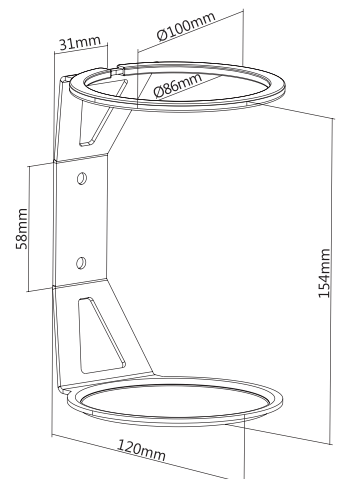
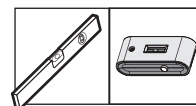
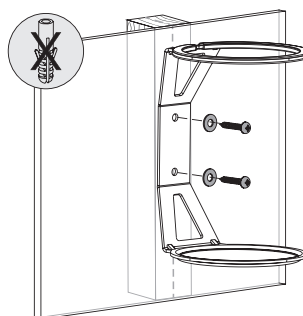
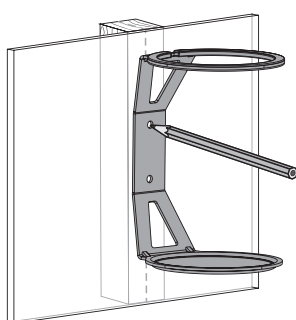

* The specifications and pictures are subject to change without notice.
*All trade names referenced are the registered trademark of their respective owners.

Made in China

LogiLink®

Wall Mount for Amazon Echo Alexa

Art. No.: BP0031
BP0032



b. Dry wall Mount

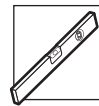
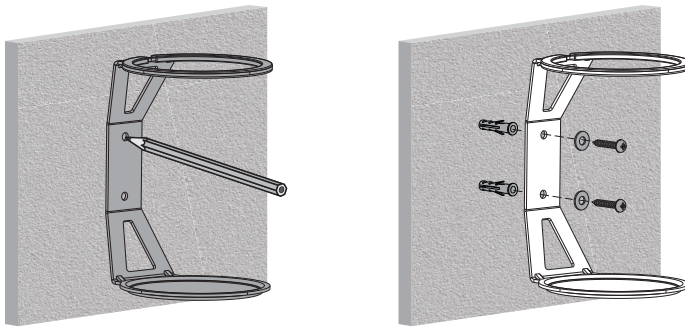

Package Contents:

- » 1 x Wall Mount for Amazon Echo Alexa

Package Informations:

- » Packing Dimension: 162 x 128 x 108mm
- » Packing Weight: 0.35kg
- » Carton Dimension: 550 x 340 x 405mm
- » Carton Q'ty: 30pcs
- » Carton Weight: 10.8kg

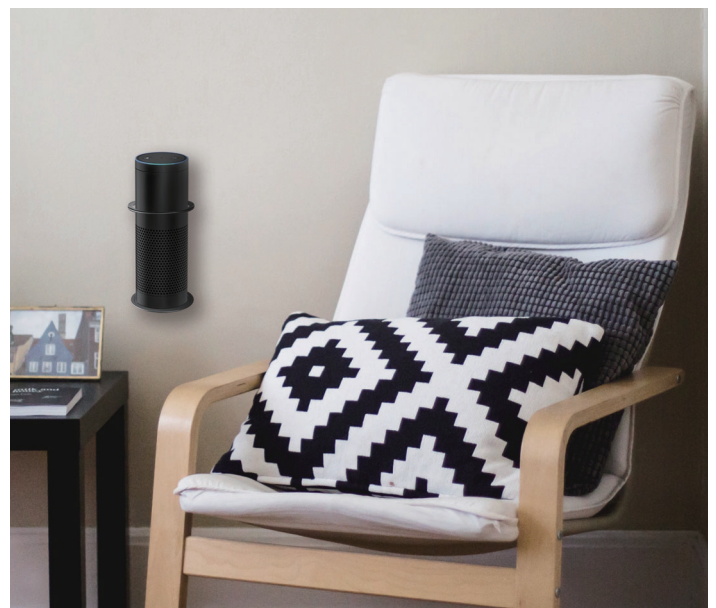

* The specifications and pictures are subject to change without notice.
*All trade names referenced are the registered namework of their respective owners.

Made in China